



CONTENTS

Tire valve

Wheel Weights

Tire Repair Seal and Patch

Tools



CAR TIRE VALVE

Name: Snap-in Tubeless Rubber Tr414 Tire Valve



Specification: TR412, TR413, TR414, TR415, TR418, TR423, TR425

Material: Natural rubber; EPDM rubber

Packing: 100 pcs/box; 10 boxes/carton

Capacity: 100000 pcs/day

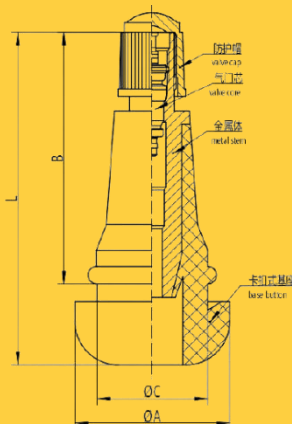

MODEL	A	B	C	L	RIMHOLE
TR412	19	22	15	33	11.5
TR413	19	32	15	42.5	11.5
TR414	19	38	15	48.5	11.5
TR415	24	32	19.3	42.5	15.9
TR418	19	51	15	61.5	11.5
TR423	19	63.5	15	74	11.5
TR425	24	51	19.3	61.5	15.9



CAR TIRE VALVE

TR412C,TR413C,TR414C,TR418C,TR415C TR412AC,TR413AC,TR414AC,TR418AC



Material: Natural rubber; EPDM rubber

Packing: 100 pcs/box; 10 boxes/carton

Capacity: 100000 pcs/day

Color: red, blue, green, yellow, etc



TR414C



TR414AC



CAR TIRE VALVE



TR161



motorcycle valve



TR525

Name: TR525 Tire valve
Material: Zinc alloy and aluminum alloy
Color: red., yellow, blue, green, pink, etc or customized
Package: normally neutral package with white carton or design as customer's request



TPMS

Aluminum alloy can do color (machine tool and CNC)



CAR TIRE
VALVE

TPMS





CAR TIRE
VALVE

TPMS

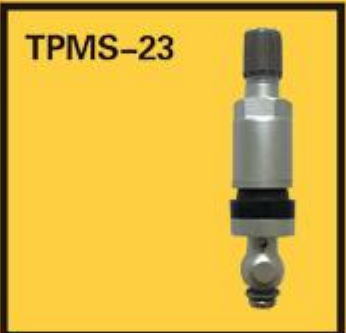



CAR TIRE
VALVE

TPMS

TPMS-31



TPMS-32



TPMS-33



TPMS-34



TPMS-35



TPMS-36



TPMS-37



TPMS-38



TPMS-39



TPMS-40





TRUCK&BUS
VALVE

TR570 SERIES



TR570

Specification:

TR500,TR501,TR502,TR571,
TR570,TR572,TR573,TR574,TR575,etc

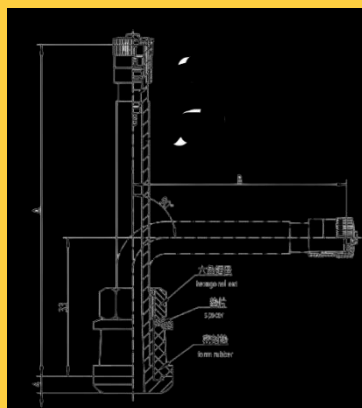
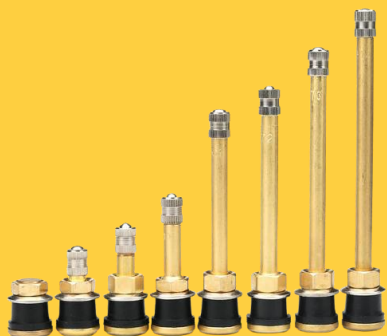

TR NO.	Effective Length(mm)
TR571	Φ19×90
TR572	Φ19×100
TR573	Φ19×115
TR574	Φ19×131



TRUCK & BUS
VALVE

V3-20 SERIES



MODEL	A	B	α	β
V3-20-1	36	—	—	—
V3-20-2	30	60	17.5	—
V3-20-3	82	—	—	—
V3-20-4	25	60	27	—
V3-20-5	25	40	27	—
V3-20-6	25	85	27	—
V3-20-7	25	50	27	—
V3-20-8	29	85	12	—
V3-20-9	45	52	12	—
V3-20-10	50	25	27	—
V3-20-11	25	—	27	42
V3-20-12	25	70	27	—
V3-22-1	25	28	45	—



TRUCK & BUS VALVE

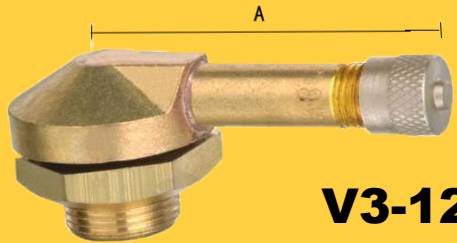

V3-12

MODEL	A
V3-12-1	40
V3-12-2	95

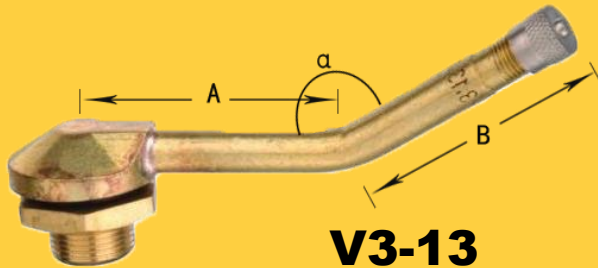

V3-13

MODEL	A	B	α
V3-13-1	46.5	425	153
V3-13-2	30	79	126

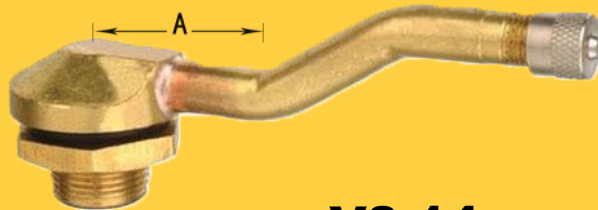

V3-14

MODEL	A
V3-14-1	26
V3-14-2	45
V3-14-3	37



TRUCK & BUS VALVE

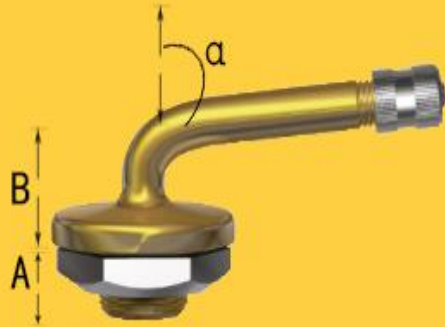

V3-15

MODEL	A	B	α
V3-15-1	14	22.5	70
V3-15-2	11	15.5	85

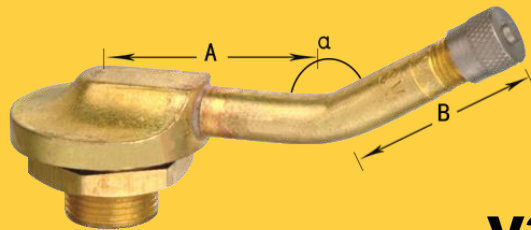

V3-16

MODEL	A	B	α
V3-16-1	36	29	150

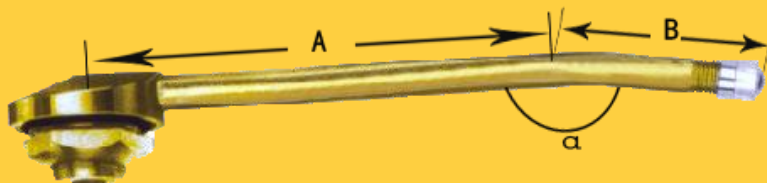

V3-17

MODEL	A	B	α
V3-17- 1	99	31.5	172°
V3-17- 2	116	31.5	172°



TRUCK & BUS VALVE

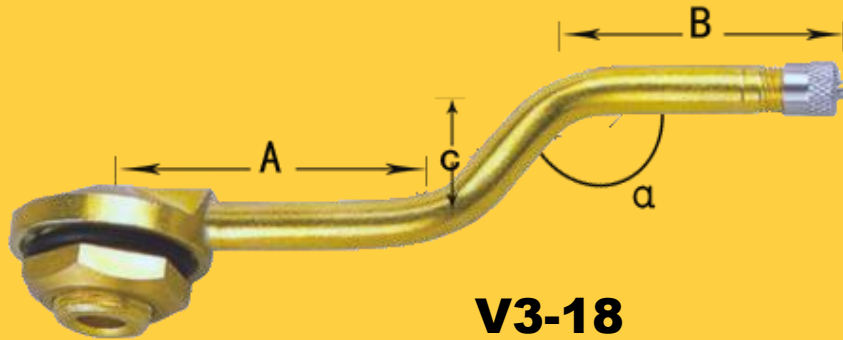

V3-18

MODEL	A	B	C	α
V3-18-1	64	24.5	14.5	146
V3-18-2	81	24.5	14.5	146
V3-18-4	51	37.5	19.5	138
V3-18-5	68	37.5	19.5	138

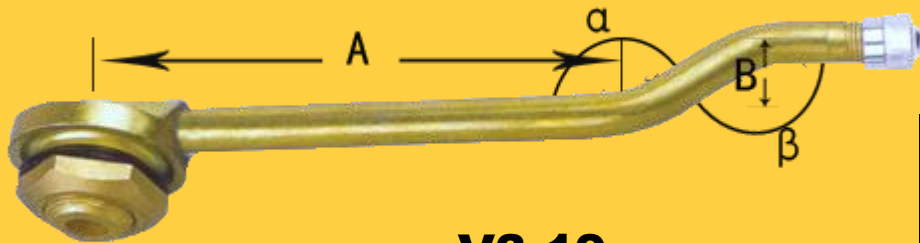

V3-19

MODEL	A	B	α	β
V3-19-1	92	14.5	154	147
V3-19-2	76	15	152	145
V3-19-3	91	10	162	155



TRUCK & BUS VALVE

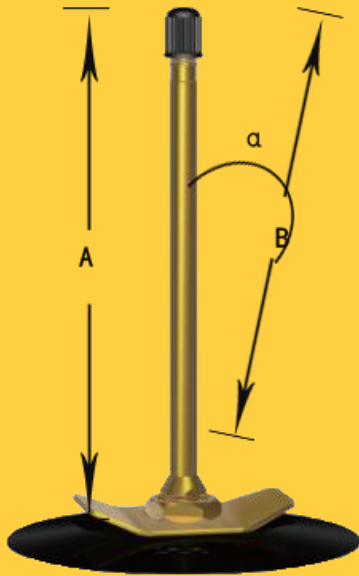

TR75A

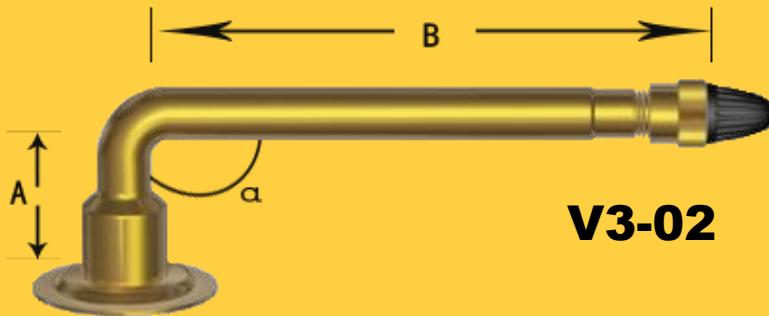

V3-02

MODEL	A	B	a	MODEL	A	B	a
JS75	89.5	70	82	TR77A	124	105	86
TR75A	95	76	86	TR175A	134	115	86
TR76A	105	86	86	TR78A	146	127	86
TR177A	114	95	86	TR179A	160	141	86

MODEL	A	B	a	MODEL	A	B	a
V3-02-2	22.5	43	120	V3-02-13	20.5	133.5	90
V3-02-3	33	44.5	95	V3-02-14	20.5	138.5	94
V3-02-4	39.5	44.5	110	V3-02-15	20.5	145.5	94
V3-02-5	20.5	47.5	90	V3-02-16	20.5	149.5	90
V3-02-7	22.5	71.5	100	V3-02-17	20.5	156.5	90
V3-02-8	20.5	89.5	94	V3-02-18	22.5	74.5	90
V3-02-9	20.5	99.5	94	V3-02-19	20.5	60	94
V3-02-10	20.5	115	94	V3-02-23	29.5	66.5	90
V3-02-11	20	126	98	V3-02-24	20.5	117	90
V3-02-12	20.5	132	94	V3-02-27	20	75	94



TRUCK & BUS VALVE

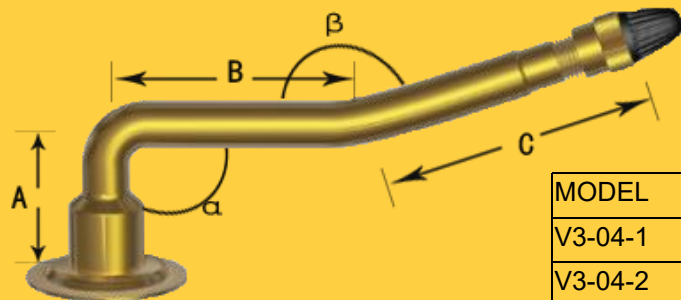

V3-04

MODEL	A	B	C	a	β	MODEL	A	B	C	a	β
V3-04-1	20.5	32	37	90	138	V3-04-7	20.5	30.5	38	90	154
V3-04-2	20.5	38	41.5	90	153	V3-04-10	20.5	47	53	90	154
V3-04-3	20	59	38.5	94	163	V3-04-11	20.5	47	63.5	90	154
V3-04-4	20	74	40	94	144	V3-04-17	20	65	45	90	160
V3-04-5	20	76	47.5	90	153	V3-04-24	20	58	47	94	164
V3-04-6	20	86	47.5	90	153	V3-04-26	20	99	42	99	189

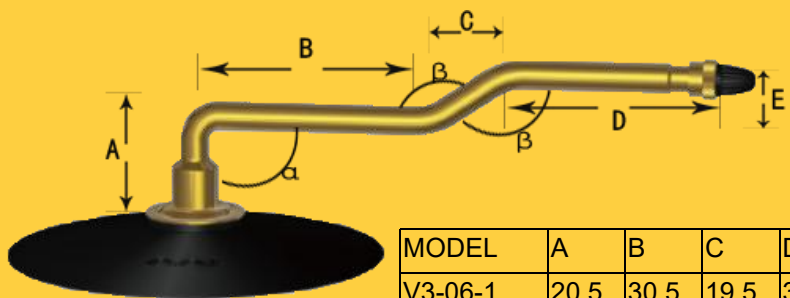

V3-06

MODEL	A	B	C	D	E	a	β	MODEL	A	B	C	D	E	a	β
V3-06-1	20.5	30.5	19.5	35.5	17	90	139	V3-06-8	24.5	61.5	14.5	50.5	7.5	94	153
V3-06-2	20.5	44.5	12	37.5	17	90	125	V3-06-9	20.5	67.5	19.5	54.5	17	90	139
V3-06-3	20.5	46	20.5	47.5	17	90	140	V3-06-12	23.5	71.5	19.5	25.5	11.5	90	150
V3-06-5	20.5	62.5	19.5	49	17	90	139	V3-06-14	20	50	13	40	7	94	153
V3-06-6	20	79.5	19.5	37.5	17	90	139	V3-06-15	20	60	13	40	7	94	153
V3-06-7	20.5	45.5	18.5	42.5	17	90	137	V3-06-16	20	62	13	50	7	94	153
								V3-06-17	20	75	13	50	7	94	153



TRUCK & BUS VALVE

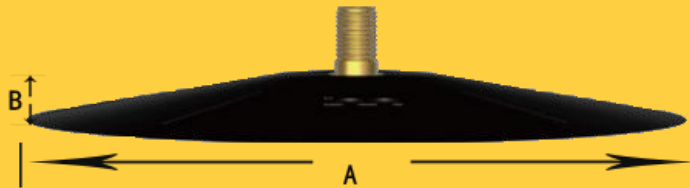

V3-08

MODEL	A	B	MODEL	A	B
V3-08	70-95	6.7	JSP1	70-95	6.7

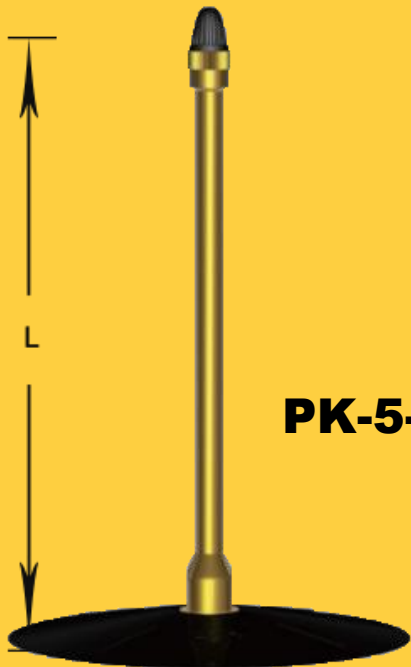

PK-5-115

MODEL	L	MODEL	L.	MODEL	L
PK-50	51	PK-135	136	PK-5-95	95
PK-95	96	PK-145	146	PK-5-115	115
PK-105	106	PK-165	166	PK-5-145	145
PK-115	116	PK-170	171	PK-5-165	165
PK-125	126	PK-260	261		



TRUCK & BUS VALVE



70MS-7

MODEL	A	B	α
70MS-7	37	28	7

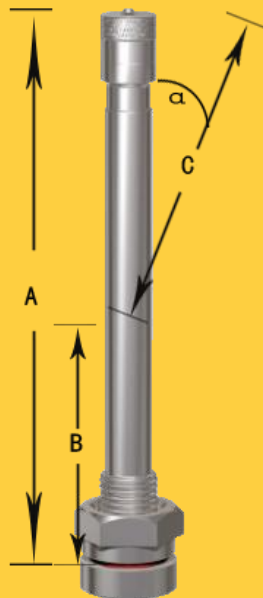

TR545

MODEL	A	B	C	α	MODEL	A	B	C	α
TR543C	—	23.5	35	45	TR546D	—	25	85	60
TR543D	—	25	35	60	TR546E	—	25	85	75
TR543E	—	25	35	75	TR547D	—	25	96	60
TR544D	—	25	49	60	TR542	32	—	—	—
TR545D	—	25	66	60	TR543	58.5	—	—	—
TR545E	—	25	66	75	TR544	72.5	—	—	—
TR546-36	—	25	85	36	TR545	89	—	—	—
					TR546	108.5	—	—	—



light truck, car
valve



V-3

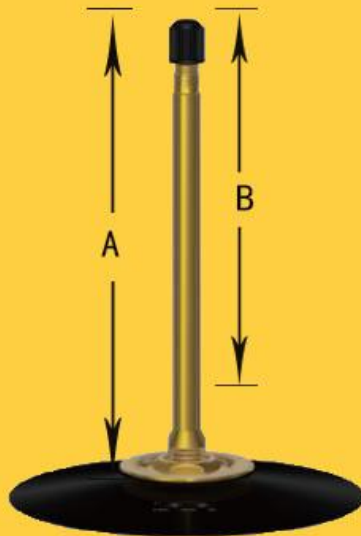

Z1-01

MODEL	A	L	α
V-3/TR33E	14	33	
V-4/TR43E	14	43	
V-5/TR48E	14	48	
V-6/TR53E	14	53	
V-7/TR63E	14	63	
VS-7/TR26A	16	34	
VS-8/TR26G	16	38	
VS-9/JS43E	16	43	
PVR98	14	53	15
PVR98A	14	53	30
PVR201	14	76	85
PVR70C/TR67E	14	63	90
VS-8-45/PVR75A	16	53	45
VS-8-30/PVR75B	16	53	30
VS-8-90/PVC75C	15	63	90

MODEL	A	B	MODEL	A	B
Z1-01-1	65	45	Z1-01-6	134	114
Z1-01-2	70	50	Z1-01-7	148	128
Z1-01-3	98	78	Z1-01-8	163	143
Z1-01-4	105	85	Z1-01-9	178	158
Z1-01-5	121	101	Z1-01-10	198	178



MOTORCYCLE VALVE



TR4

MODEL	A	B	L
TR4	45	45	345
TR4-40	40	4	34.5



PVR32

MODEL	A	L	a
PVR30	15	63	90
PVR311	18	55	90
PVR32	15	54	90
PVR32L	15	72	90



TR87

MODEL	A	B	C	L	α
TR87	45	17,19	35,33	48	60-90
J587	45	17,19	32,30	45	60-90
JS87C	45	23.5	33	52.5	60-90
JS87CL	45	30	30	56	60-90



PVR70

MODEL	A	B	α	RIM HOLE
PVR70(S)	35	27.5	90	105
PVR70	32.5	30	90	11.5
PVR40	32.5	45	90	115
PVR60	285	44	90	11.5
PVR50	32.5	27	80	8.8



MOTORCYCLE
VALVE&special
metal valve



TR43E



TR48E

PREMIER NO.	L	RIM HOLE
TR33E	33	11.3
TR43E	43	11.3
TR48E	48	11.3
TR53E	53	11.3
TR63E	63	11.3
TR67E	—	11.3

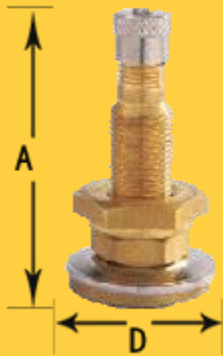

SP5

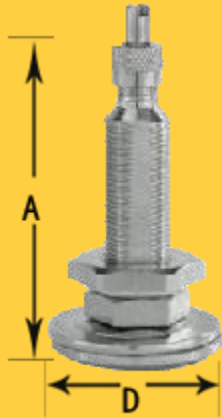

SP6



SP7

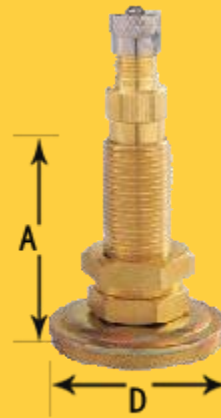

SP8

MODEL	L(mm)	D(mm)
SP5	42.5	23
SP6	54	31.5
SP7	28	31
SP8	38	31



light truck, car
valve



JS2



TR15



TR416



TR416SSS



TR416-2



TR416L



TR416L-2

MODEL	A	B	D	L
TR13	56	3	11.6	38
TR15	56	3	16.5	38
TR14	56	3	13.3	38

PREMIER NO.	L	RIM HOLE	GROMMET	WASHER	NUT
TR416	39.5	15.7	RG39	RW8	BN2
TR416S	39.5	11.3	RG54	RW8	BN2
TR416-2	39.5	11.3& 15.7	RG39+ RG54	RW8	BN2
TR416L	58.5	15.7	RG39	RW8	BN2
TR416L-2	58.5	11.3 &15.7	RG39+ RG54	RW8	BN2
TR416B	33.5	11.3& 15.7	RG39+ RG54	RW8	BN2



OFF-THE-ROAD (OTR) VALVE



TR618A



TR621A

MODEL	A	B	α	RIM HOLE
TR618A	48	—	—	15.9
TR621A	39	75	65	15.9
TR622A	44	115	90	15.9
TR623A	39	57	65	15.9



TRJ650

MODEL	A	B	α	MODEL _	A	B	α
TRJ650-03	27	79	80	TRJ657-03	27	102	80
TRJ651-03	32	119	90	TRJ658-03	27	140	80
TRJ652-03	27	140	86	TRJ659-03	48	89	90
TRJ653-03	27	64	80	TRJ660-03	48	222	90
TRJ654-03	27	79	60	TRJ669-03	27	64	90
TRJ655-03	27	79	74	TRJ670-03	41	—	—
TRJ656-03	67	94	90				



TRJ690

MODEL	A	B	C	D	α
TRJ690	32	59	119	14	28
TRJ692	32	59	119	14	18
TRJ693	22.5	62	127	25	60
TRJ695	20.5	56	105	25	50
TRJ696	27	52	108	23	42



OFF-THE-ROAD(OTR) VALVE



MODEL	A	B	a
TRJ691	16	84	18
TRJ694	20	89	28

TRJ691

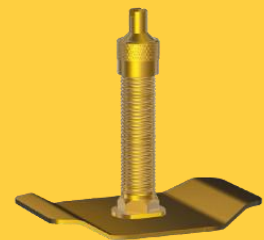

TRJ1014A



MODEL	A	B	L
TR218A	63.5.82	6.4	27.3
TR220A	63.5.82	6.4	36.9

TR218A



TRJ1175C



TRJ661



TRJ662



BICYCLE VALVE



C4E



EAV



TR1-L



VAR-L



VAR28



C3E



TR1



TR4A



TZ6-30



VFR



ACCESSORIES VALVE CORE



400



3002



5001



5002



6001



6002



6003



6004



7001



7002



7003



7004



8001



8002



8003



8004



9001



9002



9003



9004



9005



9006



TCVC01



TCVC02



ACCESSORIES

VALVE cap

metal valve cap



valve adapter

plastic valve cap



With rubber ring

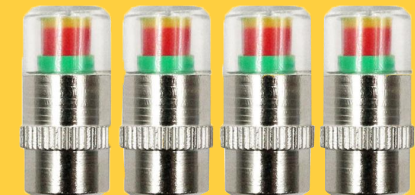

tire pressure detection valve



truck & bus extension



FEX120R



FEXU210R



FEXU180RM

NF NO.	length(mm)	NF NO.	length(mm)
FEX100R	100	FEX250R	250
FEX140R	140	FEX270R	270
FEX150R	150	FEX 300R	300
FEX180R	180	FEXU210R	210
FEX210R	210	FEXU180RM	1 80



EX95M



EX125P



EX150P



EX170P

NF NO.	length(mm)	NF NO.	length(mm)
EX70P	70	EX150P	150
EX95P	95	EX170P	170
EX115P	115	EX180P	180
EX125P	125	EX200P	200



truck & bus extension



FEXU150M



FEXU180M

NF NO.	length(mm)	NF NO.	length(mm)
FEX100M	100	FEX250M	250
FEX140M	140	FEX270M	270
FEX150M	150	FEX300M	300
FEX180M	180	F EXU180M	180
FEX210M	210	FEXU250M-AL	250



EX75M



EX100M-N



EX115M



EX115M-C



EX125M



EX140M

NF NO.	length(mm)	NF NO.	length(mm)
EX60M	60	EX125M	125
EX75M	75	EX140M	140
EX95M	95	EX150M	150
EX100M	100	EX180M	180
EX115M	115	EX200M	200



truck & bus extension





wheel weights

Fe adhesive wheel weights

Surface treatment: galvanized, gray spray, black spray

Tape: normal/wide edge, blue glue, red glue, kraft paper glue, 3M glue, Norton glue



galvanized



Gray spray



black spray

5g*12 rounded corners



(5g+10g)*4 rounded corners



(5g+10g)*4 right angle



5g*12 right angle

Other hot models

10g*6

20g*3

25g*4

30g*3

50g*3

100g*2



Gray spray



black spray



wheel weights

Fe adhesive wheel weights



1/4 OZ spraying



1/4 OZ galvanized



1/2 OZ galvanized



1/2 OZ spraying



5g*1200 / 1000

Roll fillet or right angle 5g*1200, or 1/4oz *840 disc packing
Roll fillet or right angle 5g*1000, or 1/4oz *704 disc packaging
oz wheel weight can be made: right angle / rounded / trapezoidal

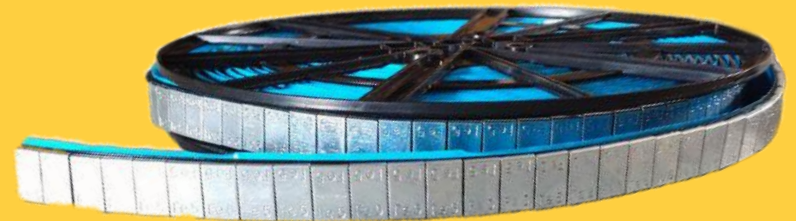



wheel weights

Pb adhesive wheel weights series



5g*12

Surface treatment: primary color, gray spray

Tape: normal/wide edge, blue glue, red glue, kraft paper glue, 3M glue, Norton glue



(5g+10g)*4



25g*10



50g*4



1 OZ*6



1/2 OZ*6

Other hot models	
rounded corners	right angle
5g*10	5g*12
(5+10)g*4	(5+10)g*4
25g*4	5g*5+10g*5
50g*4	5g*6+10g*6
(7.5g+15g) x4	10g*8
(2.5g+5g) x6	20g*5
2.5gx6+5gx7	20g*10
	25g*4
	25g*12
	20g*2+10g*2
	50g*4



wheel weights

Pb adhesive wheel weights series



blue back glue



Single: 50g/100g/150g/200g/250g



wheel weights

Zn adhesive wheel weights

Surface treatment: spraying

Tape: normal/wide edge, blue glue, red glue, kraft paper glue, 3M glue, Norton glue



(5g+10g)*4



5g*12



rounded corners

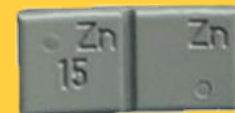
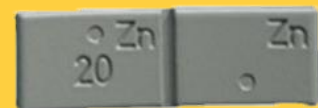
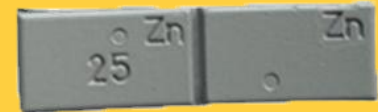
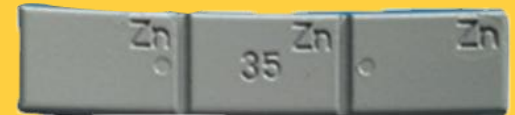
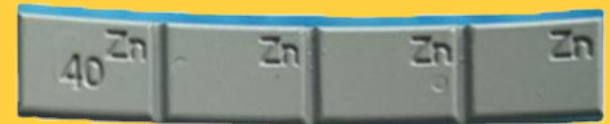



wheel weights

Fe clip-on wheel weights 5g-60g

Surface treatment:
galvanized/spraying/Dacromet



For alloy wheels



For steel wheels





wheel weights

Pb clip-on wheel weights

Surface treatment: galvanized
Specification 5-60g, 70g, 80g, 90g, 100g,
120g, 150g, 200g, 250g, 300g



Lead for **steel rim**



Lead for **Alloy Rim**



wheel weights

Pb clip-on wheel weights series -----AW / P / MC / FN / IAW / TN

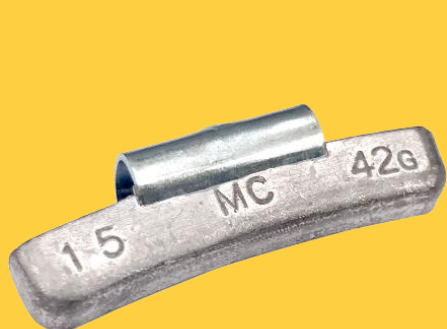

MC



AW



P



FN



TN



IAW

MC specification:	0.250Z/0.50Z/0.750Z/1.0Z/1.250Z/1.50Z/1.750Z/2.0Z
AW specification:	0.250Z/0.50Z/0.750Z/1.0Z/1.250Z/1.50Z/1.750Z/2.0Z
P specification:	0.250Z—3.0Z
AWC specification:	0.250Z—3.0Z
FN: Specification:	5g—60g
IAW specification:	5g—60g
TN specification:	0.250Z—3.0Z



wheel weights

Zn clip-on wheel weights 5g-60g



Specifications: 5g-60g
 Type: steel
 wheel/aluminum wheel
 Process: casting/die casting
 Surface treatment: spraying

Hot model	
MC specification:	0. 250Z—30Z
P specification:	0. 250Z—30Z
AWC specification:	0. 250Z—30Z
FN: Specification:	5g-60g



Tire Repair Seal and Patch



100*4mm

[black/brown]



200*4mm

[black/brown]



100*6mm

[black/brown]

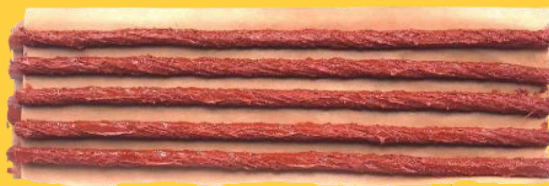

200*6mm

[black/brown]

size	Package
100x3.5mm	10strip/piece10Piece/Box60box/carton
100x4mm	10strip/piece10Piece/Box60box/carton
100x4.5mm	5strip/piece6Piece/Box120box/carton
100x5mm	5strip/piece6Piece/Box120box/carton
100x6mm	5strip/piece12Piece/Box60box/carton
200x3.5mm	10strip/piece5Piece/Box60box/carton
200x4mm	10strip/piece5Piece/Box60box/carton
200x4.5mm	5strip/piece6Piece/Box60box/carton
200x5mm	5strip/piece6Piece/Box60box/carton
200x6mm	5strip/piece6Piece/Box60box/carton
225x4.5mm	5strip/piece6Piece/Box60box/carton
192x4.5mm	5strip/piece6Piece/Box60box/carton

Tire Repair Seal and Patch

Inner tire repair patch



34×24MM



30MM

Tubeless tire patch



Inner tire patch mode	Specifice	Package
TR-1	52MM	16Piece/Box, 100box/carton
TR-2	40MM	25Piece/Box, 100box/carton
TR-3	30MM	36Piece/Box, 100box/carton
TR-6	25MM	64Piece/Box, 100box/carton
:TR-6	72X 40MM	64P iece/Box, 100box/carton
TS-1	50X 32MM	15Piece/Box, 100box/car ton
TS-2	34 X 24MM	24Piece/Box, 100box/carton
TS-4	65MM	48P iece/Box, 100box/carton
R0-65	65MM	40Piece/Box, 36box/car ton
R0-75	75MM	40Piece/Boxs 36box/carton

model	Specifice	Package
YD-30	30MM	150Piece/Box, 60box/carton
WD-40	40MM	100Piece/Box, 48box/carton
WD-52	52MM	64Piece/Box, 45box/carton
WD-75	75MM	36Piece/Box, 36box/carton



Tire Repair Seal and Patch

Radial tire patch



Bias tire patch

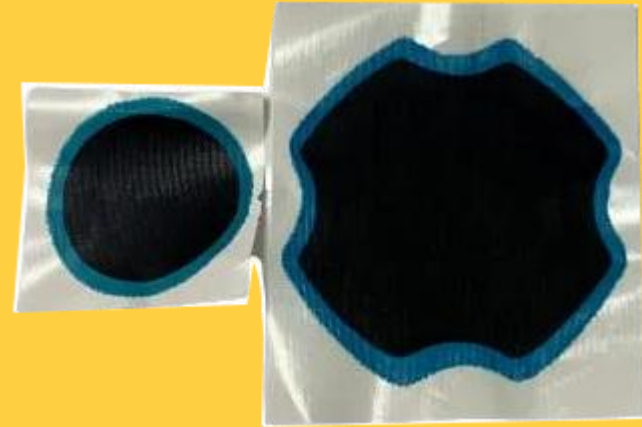

model	Specification	Package
WZ-75	55X 75MM	20Piece/Box, 50box/carton
WZ-105	65X 105MM	20Piece/Box, 25box/carton
WZ-125	80X 125MM	10Piece/Box, 30box/carton
WZ-135	92X 135MM	10Piece/Box, 24box/carton
WZ-55	92X 155MM	10Piece/Box, 20box/carton
WZ-190	130X 190MM	10Piece/Box, 9 box/carton
WZ-215	125X215MM	10Piece/Box, 8box/carton
WZ-280	140 X 280MM	5Piece/Box, 10box/carton
WZ-340	140 X 340MM	5Piece/Box, 8box/carton
WZ-440	180X 440MM	5Piece/Box, 4box/carton
WZ-570	180X 570MM	5Piece/Box, 4box/carton
WZ-600	240 X 600MM	5Piece/Box, 3box/carton

model	Specification	Package
WX-01	75X 75MM	20Piece/Box, 24box/carton
WX-02	105X 105MM	10Piece/Box, 24box/carton
WX-03	135X 135MM	10Piece/Box, 18box/carton
WX-04	175X 175MM	1 OPiece/Box, 8box/carton
WX-05	215X215MM	10Piece/Box, 4box/carton
WX-06	260 X 260MM	10Piece/Box, 4box/carton
WX-07	300 X 300MM	5Piece/Box, 5box/carton
WX-08	350 X 350MM	5Piece/Box, 3box/carton
WX-09	400 X 400MM	5Piece/Box, 3box/carton



Other shapes tire patch and mushroom nails

multifunctional tire patch



Mushroom nails

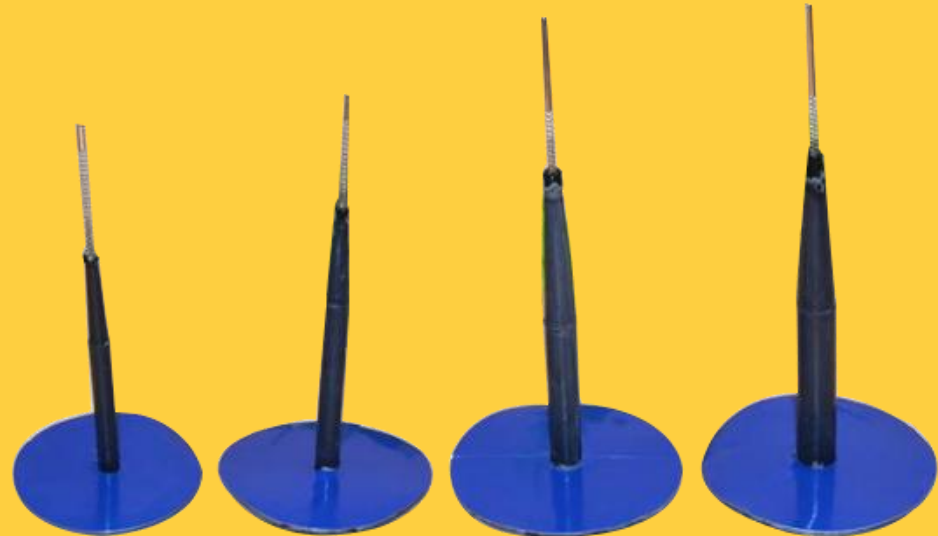

PRODUCT MODEL	PACKAGEING
3mm diameter	24 pieces/box, 12 boxes/carton
4.5mm diameter	24 pieces/box, 8 boxes/carton
6mm diameter	24 pieces/box, 8 boxes/carton
8mm diameter	24 pieces/box, 8 boxes/carton



Tire Pressure Gauge



Imitation gold oil gauge tire press gun



Electronic digital tire pressure gun



Copper nozzle pointer tire press gun



Ordinary pointer tire press gun



Mechanical pointer tire press gun



Oil immersed tire press gun



Tire Repair Tools



Digital tire pressure gauge



Boutique Mini tire press gun



Inflation rod of tire pressure gauge



Inflation rod of tire pressure gauge

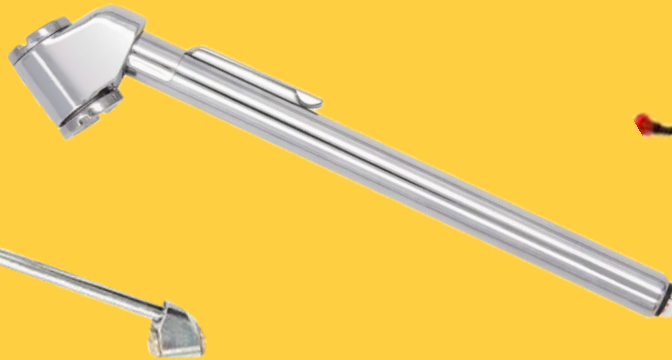

tire pressure pen



Hand operated inflation rod with Watch



Tire Repair Tools



Cigarette bag inflation rod



Double head quick inflation rod



Double head quick inflation rod



Tire inflation rod



Inflatable extension tube



Hand operated inflation rod



Tire Repair Tools



Quick inserting inflation rod



Straight inflation rod



Large T-shaped inflation rod



Cross socket wrench series



tire wrench



Double head quick inflation rod



Tire Repair Tools



Pliers type filter wrench



Pliers type filter wrench



Pliers type filter wrench



Gasoline pipe removal pliers



Gasoline pipe removal pliers



High carbon steel cap filter wrench

Tire Repair Tools



grinding ball



Eccentric screw



scrapers, wheel weight spatulas



Pressure wheel



Tire Repair Tools

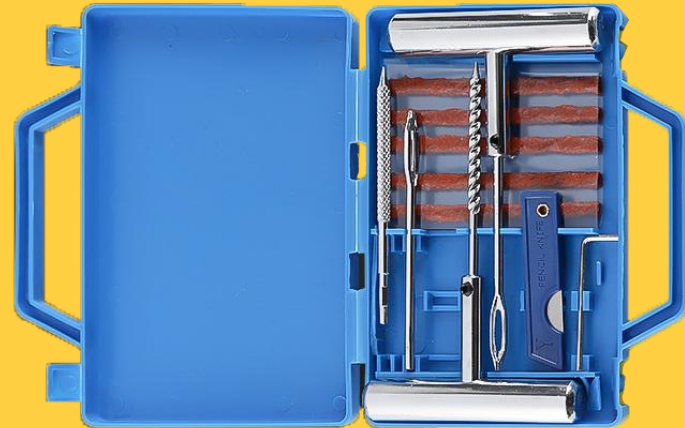



IMPACT WRENCH



BM-3880



BM-7032



BM-8810



BM-950



BM-3880T



BM-7032T



BM-8810T



BM-799



Tire Repair Tools





Tire Repair Tools





Tire Repair Tools



Valve core installation tool

valve installation tool

Valve valve core tool



Tire Repair Tools

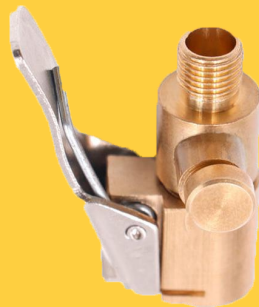
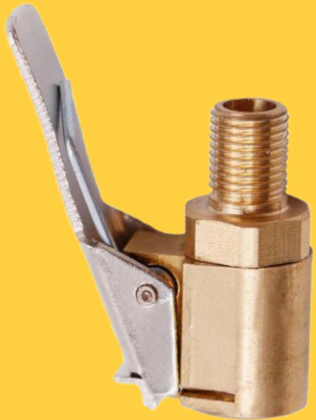



Tire Repair Tools





tire nuts

